

RESEARCH

The mass/count distinction in Japanese from the perspective of partitivity

Akira Watanabe

University of Tokyo, 7-3-1 Hongo, Bunkyo-ku, Tokyo, JP
akirawat@l.u-tokyo.ac.jp

This article presents a novel set of observations concerning partitive constructions that indicate that bare nouns in Japanese can be marked with the singular/plural distinction, despite the absence of its overt morphological reflection. The new data set challenges the currently dominant view that bare nouns are number-neutral in classifier languages. A way of accommodating the phenomenon with the syntactically represented singular/plural distinction is provided. Implications for noun classification are also discussed. It is then concluded that it is a mistake to regard Japanese nouns with count semantics as *furniture*-type nouns and that we need to recognize the familiar mass/count distinction in the language.

Keywords: bare nouns; classifier languages; mass/count distinction; mass plurals; number marking

1 Introduction

There are two major views as to the nature of bare nouns in classifier languages like Chinese and Japanese. One, represented by Chierchia (1998), says that all bare nouns in this type of language are essentially mass nouns, requiring a classifier for the purposes of counting. The other, advocated by Krifka (1995) and Borer (2005), takes a universalist position in postulating more or less the same structural resources for counting in classifier languages and those with regular plural morphology such as English. These two views agree, however, that bare nouns in classifier languages are not provided with the singular/plural distinction, an idea also endorsed in a recent overview by Doetjes (2012). And indeed, bare nouns in Japanese have traditionally been assumed to be number-neutral (Martin 1975; Nakanishi & Tomioka 2004; Nomoto 2013). In the context of classifier languages, the number-neutrality of bare nouns has often been linked to the role of classifiers, which are considered to provide a counting unit. The phenomenon of bare nominals is more general, however, extending beyond classifier languages, as documented in detail by Wilhelm (2008) and Paul (2012).

The goal of this paper is to show that the currently dominant conception of bare nouns in classifier languages is misguided, by presenting a novel piece of evidence that bare nominals in Japanese can be associated with plurality that is reflected in syntactic computation and semantic interpretation. The key observation is that partitive constructions display a systematic sensitivity to the singular/plural distinction even though no additional number-sensitive overt material is employed. Specifically, there is a systematic correlation between word order and number interpretation. In other words, Japanese exhibits count syntax not mediated by a classifier. The observation opens up the possibility that the number-neutrality of bare nouns is only apparent and that the syntactic singular/plural distinction happens to be simply masked by the absence of its overt indicator in most of the

situations. A rare case where the singular/plural distinction is vital in Japanese, therefore, deserves careful theoretical attention. The minimal requirement for an adequate analysis is to provide a precise syntactic basis for the fact that systematic number-sensitive word order variation is found with a certain class of partitive constructions in Japanese. It will be shown that the syntactically represented singular/plural distinction is an important factor that is related to the word order alternation.

Once the singular/plural distinction is recognized for Japanese bare nouns, there immediately arise questions about noun classification in terms of number. It turns out that partitive constructions provide a litmus test that enables us to identify ordinary mass nouns and mass plurals in addition to count nouns. We will be thus led to conclude that Japanese has essentially the same range of noun classes that languages like English have, a surprising result given the currently prevalent conception of Japanese.

This article is organized as follows. Section 2 presents basic number-related empirical data concerning partitive constructions in Japanese. Section 3 proposes an account of the data on the basis of the syntactic analysis of partitive constructions. Section 4 pursues obvious consequences of the proposed analysis for the mass/count distinction in Japanese, pointing out that we have to acknowledge the existence of plural mass nouns in Japanese. Section 5 compares the proposed account with previous studies on partitives. Section 6 concludes the discussion.

2 Data

The crucial evidence for number sensitivity of bare nouns in Japanese comes from partitive constructions. The (a) and (b) sentences in (1)–(3) below contrast in the number interpretation of the whole.

- | | | | |
|-----|----|--|-------------|
| (1) | a. | Ringo-no ichibu-ga kusatteiru.
apple-GEN part-NOM is.rotten
'Part of the apple(s) is/are rotten.' | ambiguous |
| | b. | Ichibu-no ringo-ga kusatteiru.
part-LINK apple-NOM is.rotten
'Some of the apples are rotten.' | unambiguous |
| (2) | a. | Ringo-no hotondo-ga kusatteiru.
apple-GEN most-NOM is.rotten
'Most of the apple(s) is/are rotten.' | ambiguous |
| | b. | Hotondo-no ringo-ga kusatteiru.
most-LINK apple-NOM is.rotten
'Most of the apples are rotten.' | unambiguous |
| (3) | a. | Ringo-no dai-bubun-ga kusatteiru.
apple-GEN large-part-NOM is.rotten
'Most of the apple(s) is/are rotten.' | ambiguous |
| | b. | Dai-bubun-no ringo-ga kusatteiru.
large-part-LINK apple-NOM is.rotten
'Most of the apples are rotten.' | unambiguous |

In (1a), (2a) and (3a), the whole can be a single apple or multiple apples. These cases can be cited as examples of familiar number-neutral bare nouns. In (1b), (2b) and (3b), on the other hand, the whole cannot be a single apple. It must be plural. Furthermore, more than one apple must be rotten. Notice that apart from the difference in word order, the

shape of the noun *ringo* ‘apple’ does not vary, appearing bare without any morphological piece indicative of number information. We are led to conclude that word order helps disambiguation. The observation concerning the interpretive properties of (2) is due to Sauerland & Yatsushiro (2004), but the pattern is more general, found in cases like (1) and (3) as well. So the phenomenon cannot be reduced to lexical idiosyncrasies of *hotondo*. The empirical challenge is to account for the systematic correlation between word order and interpretation.

In English partitives, no ambiguity exists in the first place due to the availability of plural morphology, as shown in (4).

- (4) a. Most of the city is off-limits to foreigners.
b. Most of the cities are off-limits to foreigners.

Cases like (4a) are called mass partitives in the literature (Hoeksema 1996: 2), but the important point is that the whole is a singular entity. Note also that the word order is fixed regardless of interpretation in English.

An initial step towards a principled account of the word order effect in Japanese partitives is to say that the (a) examples in (1)–(3) are structurally comparable to (4a, b). The idea that bare nouns mark no singular/plural distinction in Japanese is consistent with the ambiguity of (1a), (2a) and (3a). But assuming number-neutrality of bare nouns leaves completely open why changing the word order leads to disambiguation as in the (b) examples of (1)–(3), which will be called *reverse partitives* following the terminology of Sauerland & Yatsushiro (2004).

There is another way of disambiguating (1a). Consider (5).

- (5) a. Ringo-no uchi-no ichibu-ga kusatteiru.
apple-GEN out.of-LINK part-NOM is.rotten
‘Some of the apples are rotten.’
b. ??Ringo-no uchi-no hotondo-ga kusatteiru.
apple-GEN out.of-LINK most-NOM is.rotten
‘Most of the apples are rotten.’
c. ?Ringo-no uchi-no dai-bubun-ga kusatteiru.
apple-GEN out.of-LINK big-part-NOM is.rotten
‘Most of the apples are rotten.’

Here, *uchi-no* ‘out of’ is added, knocking out the interpretation under which the whole is singular. I find (5b) and (5c) are marginal to varying degrees, but a reviewer notes that they are acceptable. There may be speaker variation. At any rate, it is very clear that the whole must be interpreted as plural in these examples.

For cases like (5), one could say that *uchi-no* simply filters out the singular interpretation, keeping intact the number neutrality of bare nouns denoting the whole entertained under the current views concerning classifier languages. But one might wonder how the number-neutral denotation of the bare noun should be shifted to the plurality or how filtering works. For the word order effect illustrated in (1)–(3), there is currently no way of pursuing a filtering approach any further. Since the reverse partitives in (1b)–(3b) contain no overt item that can be associated with the filtering function, a covert one must be posited to account for the disambiguation effect under such an approach. In order for that account to become viable, however, independent evidence for the existence of such a covert item in reverse partitives must be found in the first place. Furthermore, it must also be guaranteed that the obligatory presence of the covert filtering device is limited to reverse

partitives. As far as I can see, it is not clear how to proceed to meet these challenges while adhering to the number neutrality of bare nouns. In the next section, I will provide a syntactic analysis of the two possible word orders and show that the disambiguation effect is linked to the interaction between number marking of bare nouns and the mechanism responsible for the word order of reverse partitives.

3 Analysis

The point of departure is the idea that the noun *ichibu* ‘part’ or *bubun* ‘part’ takes a complement that is interpreted as a whole.¹ There is no overt noun indicative of the part-whole relation in (2), but I assume following Chierchia’s (1997) and Hallman’s (2016) analyses of partitives that there is a covert noun meaning ‘part’.² See also Kayne (2016) on the covert version of *part* associated with *most* in English. (1a), (2a) and (3a) reflect the head-complement structure transparently, with genitive marking of the complement on the left. To get the order in (1b), (2b) and (3b), where the head precedes the complement, I propose a remnant movement analysis that makes use of the structure in (6), which Watanabe (2006, 2008, 2010b) crucially relies on to provide an account of why the numeral-classifier sequence can appear in various positions in relation to the head noun and the case particle.

(6) $[_{DP} [_{QP} [_{CaseP} [_{#P} NP \#] Case] Q] D]$

The analysis of reverse partitives to be worked out below is not only built on the structure in (6) but also utilizes a movement step that plays a role in the analysis of the numeral-classifier sequence. Let us therefore review Watanabe’s (2006, 2008, 2010b) account first and then turn to reverse partitives.

3.1 DP structure

In Japanese, the position of the numeral-classifier sequence is not fixed vis-à-vis the head noun and the case particle, as illustrated in (7) with nominative marking.

- (7)
- a. ringo ni-ko-ga
apple two-CL-NOM
 - b. ni-ko-no ringo-ga
two-CL-LINK apple-NOM
 - c. ringo-ga ni-ko
apple-NOM two-CL
‘two apples’

Watanabe (2006) proposes that these three structures share the configuration in (8), with the classifier occupying the position of the # head. The numeral is placed in Spec of #P.

(8) $[_{#P} ni [_{\#}, [_{NP} ringo] [_{\#} ko]]]$
two apple CL

¹ One might wonder about the status of what appears to be the numeral *ichi* ‘one’ contained in *ichibu*. But there is no sense of singularity associated with *ichibu*. For countable parts, there is a separate lexical item *bubun*. The latter can also be used in partitives, but only in combination with a bound morpheme *dai* meaning ‘large’ as in (3). It is therefore appropriate to treat *ichibu* as a non-phrasal, head-level expression.

² I leave open the exact status of *hotondo* ‘most’ in (2), though it should be included in the NP headed by the covert version of *bubun* ‘part’ in the analysis presented below. In the following exposition, I concentrate on *ichibu*, but the same account carries over to *hotondo* and *dai-bubun* ‘large part’.

(7a) is derived by obligatory movement of NP to Spec of CaseP, as in (9a), to which optional raising of #P to Spec of QP applies to produce (7b), as in (9b), to which the linker *no* is added right after the raised #P.³ If CaseP in (9b) is raised to Spec of DP, we get (7c), as in (9c).

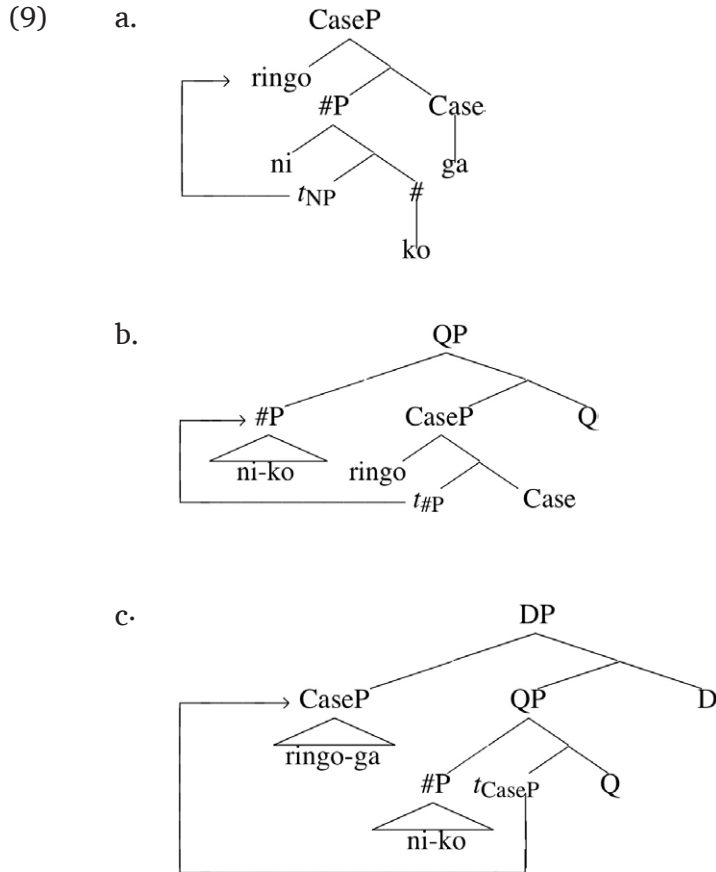

For further details, see the references cited.

It is also important to emphasize at this point that the # head is the locus of number information. Consider the classifier for human beings, which changes its shape, as in (10).

- (10) a. hito-**ri** (-no gakusei)
1-CL -LINK student
'one (student)'
- b. futa-**ri**
2-CL
- c. san-**nin**, yo-**nin**, go-**nin**, etc.
3-CL 4-CL 5-CL

The distinction between dual and plural (> 2) is made possible by the feature system in (11), as discussed by Harbour (2007), Nevins (2011), and Noyer (1997), among others.

³ On the distinction between the linker and the genitive marker, see Watanabe (2010a). The linker is a morphological piece not reflected in syntax. It is also added to *ichibu* 'part' in (13b) below. Since it attaches only to pronominal elements, it does not appear in (7a)/(9a).

- (11) a. Singular: [+singular, -augmented]
- b. Dual: [-singular, -augmented]
- c. Plural: [-singular, +augmented]

The form *-ri* corresponds to the natural class defined by [-augmented] in this system, as noted in Watanabe (2010b). Though this is the only classifier in Japanese whose form is sensitive to number, it provides evidence that the # head carries the number features in (11).

3.2 Reverse partitives

We are now ready to take up the analysis of reverse partitives in detail. Let us proceed step by step.

The challenge is how to get the order of reverse partitives in (1b), (2b), and (3b) from the head-final structure, exemplified by (12) for (1b).

- (12) [_{#P} [_{NP} ringo ichibu] #]
 apple part

My proposal is that the complement of *ichibu/bubun* (or their covert version) is moved out of NP to Spec of #P as in (13a) and then the NP headed by *ichibu/bubun* is raised to Spec of CaseP as in (13b), to which QP and DP are subsequently added without further word order change.

- (13) a. [_{#P} ringo [_{NP} t ichibu] #]

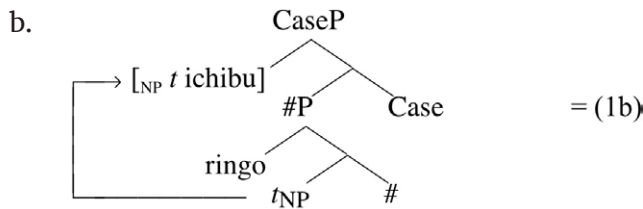

Recall that the movement that derives (13b) from (13a) is independently motivated for the analysis of the numeral-classifier sequence. The same movement applies to (8) to derive (9a). What is novel is the step from (12) to (13a). Let us examine its nature in detail.

First of all, what is raised to Spec of #P in (13a) is not the entire complement of *ichibu* but its NP portion, strictly speaking. The complement of *ichibu* is DP with the internal structure of (6), and one should ask which projection gets raised. The answer comes from the semantic import of the movement in question and the syntactic mechanism of movement. Raising NP from within the complement of *ichibu* serves to add descriptive content to the denotation of the relevant part, specifying what kind of individual is denoted by the part. In the examples in question, it is apples. Thus, only the NP headed by *ringo* is raised. The driving force of this movement is agreement triggered by the [-singular] feature of the # head, which accords well with the fact that the reverse partitives of (1b), (2b), and (3b) force the reading where multiple apples are rotten. The # head usually agrees with its complement NP in number features, but I assume that *ichibu* lacks number specification, which allows the # head to search for some other NP specified as [-singular] further down the structure.

Let us consider how semantic interpretation works in more precise terms. Assuming that the complement of *ichibu* is a definite expression, as is typically the case with partitives (see de Hoop 2003 and the references cited there), we can say that the NP headed by the two-place predicate *ichibu* denotes (14a) in the case of the plural whole, using the iota operator for definites.

- (14) a. $\lambda x.\text{part}(x, \iota y \text{ apples}(y))$
 b. $\lambda x. [\text{part}(x, \iota y \text{ apples}(y)) \wedge \text{apples}(x)]$

When the pluralized NP headed by *ringo* is raised to Spec of #P, it is interpreted conjunctively, as in (14b). The conjunctive interpretation is not an ad-hoc device for reverse partitives. Numerals placed in Spec of #P are interpreted in a similar fashion. The interpretation of *five apples*, for example, is (15a) at the level of #P, where *x* is a plural individual, to use the cardinality notation for the sake of simplicity to specify the number of atomic individuals contained in *x*, with the contribution of the numeral itself being (15b).⁴

- (15) a. $[[\text{five apples}]] = \lambda x. [\text{apples}(x) \wedge |x| = 5]$
 b. $[[\text{five}]] = \lambda x. |x| = 5$

Suppose that the # head that hosts some expression in its Spec acts semantically as introducing \wedge as in (16), where *P* and *Q* are variables for one-place predicates.

- (16) $[[\#^\circ]] = \lambda P \lambda Q \lambda x. [P(x) \wedge Q(x)]$

What gets raised to Spec of #P in partitive constructions must, therefore, be predicative in nature.⁵

Incidentally, the above account leaves open the possibility that raising of the #P buried inside the complement of *ichibu* may be a viable option, as long as the # head that does not project Spec simply passes on the NP denotation and acts as a one-place predicate. Syntactically, however, this #P is not eligible for raising, since movement of NP to Spec of CaseP also takes place downstairs. (12) should be elaborated more precisely as (17).⁶

⁴ Here, I gloss over various issues concerning the semantics of numerals. See Krifka (1995), Ionin & Matushansky (2006), Wilhelm (2008), Kennedy (2013), Bale & Coon (2014), and the references cited there. The treatment here subscribes to the predicative view on numerals. See also Watanabe (2017) on the relation between numerals and natural number concepts.

⁵ A reviewer wonders whether the NP placed in Spec of #P in (13) blocks the appearance of a numeral under the intended reading. It does, as shown in (i), no matter whether the numeral is above or below *ringo*.

- (i) a. **ichibu-no* 40-ko(-no) *ringo*
 part-LINK 40-CL(-LINK) apple
 b. **ichibu-no* *ringo* 40-ko
 part-LINK apple 40-CL

Though this is the correct prediction, the appearance of a numeral may be constrained further by number features located in the # head. See Watanabe (2010b, 2014), where it is proposed that a numeral must be licensed by [\pm augmented]. Note also that when *ichibu* acts as a separate modifier with its whole understood independently in the context, examples like (i) become acceptable, meaning something like ‘40 apples that are part’. In that case, the whole is not necessarily a set of apples.

In Section 3.3, I will come back to cases where the numeral is associated with the whole.

⁶ I am inclined to think that QP is absent in this case, since QP would be semantically vacuous here.

(17)

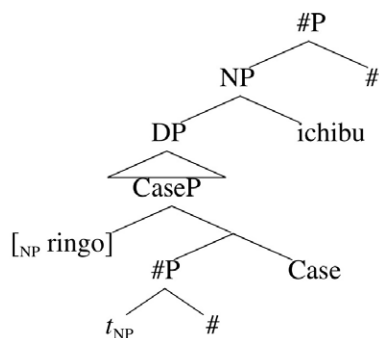

The NP headed by *ringo* is closer to the higher # head and thus is chosen for the target of movement.⁷ Raising of NP to Spec of CaseP plays an important role here as well.

The role of [-singular] located in the # head is to make sure that a predicate selecting a plural individual appears in the interpretation. I hypothesized above that *ichibu* is devoid of number features, failing to agree with the # head in [\pm singular], which means that (14a) cannot be passed on as the denotation of the entire #P when the # head contains [-singular]. The part relation that appears in (14) is interpreted as $\lambda y \lambda x [x < y]$, with no further restriction on the x variable. Movement of a plural NP from within the whole to Spec of #P serves to narrow down this general part relation to that between individual apples through the conjunctive interpretation as in (14b), satisfying the [-singular] requirement of the #head at the same time.

The underspecified general part relation (see also Moltmann's 1998 discussion of *part* in English) is needed to accommodate both singular and plural wholes for cases like (1a)–(3a) in a unified fashion. Let me stress that there is no reason to suppose that the variability of the exact part relation in question is determined solely by whether the whole is singular or plural. One might entertain the possibility, as suggested by a reviewer, that when the whole is plural, the part relation contributed by *ichibu* tracks the join semilattice structure of the kind familiar since Link (1983), where **apple**₁ \oplus **apple**₂ counts as part of **apple**₁ \oplus **apple**₂ \oplus **apple**₃ under sum formation with \oplus , for example, unlike when the whole is singular. The fact of the matter, however, is that the plurality of the whole itself does not guarantee that the part relation is restricted to the mereological structure involving the sum operation. In the case of a plural whole, (1a), (2a), and (3a) can have a reading in which each individual atomic apple is partially or mostly rotten (just as in the case of a singular whole), in addition to the reading in which some or most of the apples are rotten. In other words, one needs to be able to refer to part of an atomic individual even when the whole is plural. The part relation itself, therefore, should be underspecified in such a way as to be able to cover these distinct modes of interpretation. The reverse partitives in (1b), (2b), and (3b), on the other hand, lack the former reading, which refers to part of an atomic individual, as correctly predicted by the proposed analysis given as (14b). It is therefore wrong to think that the plurality of the whole itself makes a difference. What plays a crucial role in reverse partitives is movement of a plural NP from within the whole to Spec of #P that leads to the interpretation in (14b). This movement has a consequence of turning the underspecified part relation into the join semilattice in effect and thereby ruling out the reading according to which the atomic individuals comprising the plural whole are partially or mostly rotten. The part relation denoted by *ichibu* and so on should therefore be flexible enough to be able to accommodate parthood

⁷ Cf. Rizzi's (1990) Relativized Minimality. Chomsky (2000) reduces it to locality on the agreement operation, which is considered to be a precondition for movement.

of atomic individuals as well as semilattice structure of plural individuals. Out of these interpretive options, only those compatible with a given syntactic configuration become available. Let me also add that the number specification of the # head together with the raised NP in its Spec excludes the mass reading of the part for this class of nouns. It is well known (Borer 2005; Pelletier 2012; and the references cited there) that explicitly number-marked expressions like *an apple* are interpreted as countables. To anticipate what is to come, Section 4 takes up mass nouns.

One might wonder what happens if [+singular] instead of [-singular] is involved. The answer is that the whole and its part cannot be a [+singular] apple at the same time due to the proper part-whole relation imposed by *ichibu*. In other words, when the # head contains [+singular], movement of the NP portion of the whole to Spec of #P produces a semantically incongruous result of a singular individual being proper part of another singular individual of the same kind.⁸ A proper part of an apple is not an apple. Note also that a similar reasoning also rules out raising of the whole itself even on the assumption that the whole can be type-shifted into a predicative interpretation, for proper part cannot be equated with the whole.

Now notice that if the NP contained in the complement of *ichibu* ‘part’ cannot move to Spec of #P unless #° has [-singular], the disambiguation effect observed in reverse partitives is accounted for. The whole is necessarily plural when its NP portion is raised. Significantly, the proposed account rests on the hypothesis that a bare NP is marked with [\pm singular], thereby supporting it.⁹

Given the possibility of [\pm singular] marking without the help of a classifier in Japanese, the plurality requirement imposed on the whole in (5) can also be phrased in those terms. Consider (5a), repeated below.

- (5) a. Ringo-no uchi-no ichibu-ga kusatteiru.
 apple-GEN out.of-LINK part-NOM is.rotten
 ‘Some of the apples are rotten.’

Specifically, we can say that *ichibu* selects a plural individual through a P-like element *uchi-no*.¹⁰ This use of *ichibu* does not need to be supplied with additional descriptive content from the NP portion of the whole. At the same time, the interpretation of the part relation assumed for (14) will leave open what kind of part is rotten for examples like (5a). Significantly, (5a) disallows the reading where each of the apples is partially rotten, unlike (1a). We are therefore led to assume that for cases like (5a), it is necessary

⁸ Here is a proof by *reductio ad absurdum*.

- (i) Suppose that the whole is a [+singular] apple and furthermore that there is a proper part of that whole that counts as a singular apple. By the same logic, there will be another proper part that is also a singular apple. But then, the whole will be two apples or more, not a singular apple, contrary to the premise.

This impossibility of cumulative reference used in the last step, stemming from Quine’s (1960) original discussion, is a basic property of atomic individuals represented by singular count nouns. See Lasnik (2011). Two reviewers note that there are count nouns discussed in the literature such as *sequence*, *rope* and *line* problematic for the reasoning in the above proof, saying that a proper part of a rope, for example, is also a rope. This intuition about these nouns repeated in the literature is actually a fallacy arising from confusing results of abstract or concrete cutting with proper parts. Furthermore, as long as items like *sequence*, *rope* and *line* behave just like ordinary count nouns with respect to the use of numerals, they do not pose any problem for the proof above, which crucially involves numerals and an act of counting. These points are taken up in the appendix.

⁹ Krifka (1989), Sauerland et al. (2005), and Zweig (2009), among others, argue that plural NPs include atomic as well as plural individuals, the limitation to the ‘more than one’ reading arising as an implicature. Independently of this issue, the plurality of the whole in reverse partitives is ensured by the proper part relation involved.

¹⁰ For some discussion of the adpositional system in Japanese, see Watanabe (2009).

to invoke the part relation that holds between individual apples in the join semi-lattice structure. This semantic difference should be linked to the selectional property of the part noun.

3.3 Intervention effects

Now, the remnant movement analysis of reverse partitives illustrated in (13b) forces us to ask whether (1a), (2a), and (3a) reflect the original head-complement configuration or is derived by some additional remnant movement that applies to the structure exemplified by (13b). In fact, if movement of #P to Spec of QP, reviewed in Section 3.1, applies to (13b), we get (18).

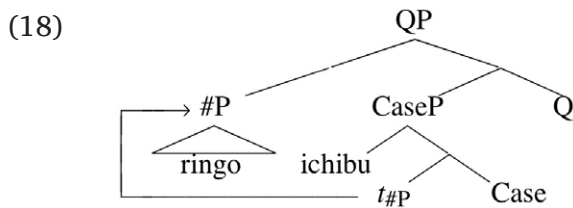

The question is whether (1a), for example, has the structure in (18) when the whole is interpreted as plural. The question does not arise for the singular whole, which is not allowed in (1b) in the first place.

The ambiguity of the plural-whole case of (1a) noted above in comparison with (1b) already suggests that the plural-whole interpretation of (1a) can be associated with the structure in which the NP portion of the complement of *ichibu* is not raised to Spec of #P, reflecting the original head-final structure. But there is syntactic evidence as well. The demonstration of this point will be built on intervention effects exhibited by the raising of NP that transforms (12) into (13a), which is linked to the plural-whole interpretation. In other words, there are cases where the NP portion of the plural whole is prevented from moving into the higher #P. Note that if the NP portion of the whole is not raised to Spec of #P, the set of movement options employed for the analysis of the numeral-classifier sequence does not give rise to word order reversal.

To illustrate the intervention effect in question, let us start with the interaction between a demonstrative and the partitive constructions. Observe that the inverted order of (1b) does not allow the whole to be modified by a demonstrative, unlike the order in (1a), as shown in (19). The same contrast holds for (2) and (3), though I omit examples.

- (19) a. Sorera-no ringo-no ichibu-ga kusatteiru.
 those-LINK apple-GEN part-NOM is.rotten
 ‘Some of those apples are rotten.’ ‘Those apples are partially rotten.’
- b. Ichibu-no (*sorera-no) ringo-ga kusatteiru.
 part-LINK those-LINK apple-NOM is.rotten
 ‘Some of the/*those apples are rotten.’

First of all, the impossibility of a demonstrative in (19b) indicates that raising of the NP portion of the complement of *ichibu* cannot carry a demonstrative along with it. We are

thus led to assume that the location of the demonstrative is higher than NP.¹¹ Notice also that the impossibility of a demonstrative in (19b) constitutes empirical evidence that what is raised to Spec of #P in (13a) cannot be the entire complement of *ichibu*. Recall the semantic reason for this having to do with the proper part-whole relation. Now, if the demonstrative is located outside NP, raising the NP portion of the complement of *ichibu* will strand the demonstrative as in (20a), and the subsequent movement of the NP headed by *ichibu* will produce (20b), which is completely unacceptable.¹²

- (20) a. [_{#P} ringo [_{NP} sorera-no t_{NP} ichibu] #]
 b. *Sorera-no ichibu-no ringo-ga kusatteiru.
 those-LINK part-LINK apple-NOM is.rotten
 ‘Some of those apples are rotten.’

What rules out (20b)?

The impossibility of a demonstrative in (19b) and (20b) falls into place once we notice that the plural version of the distal demonstrative is used. The singular version is *so-no* ‘that-linker’, which will force the singular interpretation of the whole if used for (19a). Though there is no consensus view concerning the position of demonstratives in Japanese, let us assume as stated in note 11 that it is in Spec of DP. Then, the [–singular] feature of the demonstrative blocks agreement between the # head associated with *ichibu* and the NP portion of the complement of *ichibu* as a familiar case of minimality/intervention. Recall note 7 and the related text discussion. Thus, the demonstrative is ruled out for (19b) and (20b). Needless to say, raising of the plural demonstrative itself fails to contribute to adding descriptive content to the denotation of *ichibu* and is thereby ruled out.¹³ All this means that (19a) does not involve movement of the lower NP. It is derived by a string-vacuous raising of the NP headed by *ichibu* to Spec of CaseP that applies to the version of (17) with a demonstrative in Spec of DP after the Case head is merged. Note also that it can mean, just like (1a), that those apples are partially rotten. We are led to conclude that movement of the NP

¹¹ The order in (i) represents a natural combination of a demonstrative and a numeral.

- (i) sorera-no ni-ko-no ringo
 those-LINK 2-CL-LINK apple
 ‘those two apples’

In view of (i), a plausible position for demonstratives is Spec of DP.

Note incidentally that an adjectival modifier can be carried along as part of NP, as shown by the well-formedness of (ii).

- (ii) Ichibu-no koukana ringo-ga kusatteiru.
 part-LINK expensive apple-NOM is.rotten
 ‘Some of the expensive apples are rotten.’

¹² (20b) is acceptable under an irrelevant reading according to which apples that are part of those are rotten. In this case, the whole does not necessarily consist solely of apples. This reading is not derived from (20a).

¹³ Note that only the order in (ia) is possible when the head noun is absent, as predicted. Compare (i) with (19).

- (i) a. sorera-no ichibu
 those-LINK part
 ‘part of those’
 b. *ichibu-no sorera
 part-LINK those

portion of the complement of *ichibu* to Spec of #P is not obligatory in the case of the plural whole.¹⁴

As a further instance of intervention effects, it is also interesting to examine the case where the whole is accompanied by a numeral. Since raising of the lower NP to the higher #P strands the numeral-classifier sequence, the remnant movement of the NP headed by *ichibu* carries the numeral with it, as in (21b).

- (21) a. *50-ko-no ichibu-no ringo-ga kusatteiru.
 50-CL-LINK part-LINK apple-NOM is.rotten
 ‘Some of the 50 apples are rotten.’

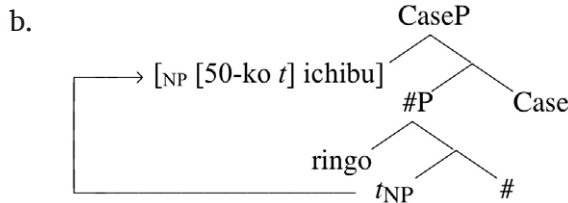

The result is ill-formed, as can be seen from (21a). Why?

To see what is going on, we need to consider all the three configurations involving a numeral-classifier sequence reviewed in Section 3.1. Of these, the placement after the case particle can be put aside. This option is independently ruled out in the case of genitive, as illustrated by (22a) under the intended interpretation.

- (22) a. *[gakusei-no san-nin](-no) oya
 student-GEN three-CL(-LINK) parent
 ‘parent(s) of (the) three students’
 b. *[ringo-no 50-ko](-no) ichibu
 apple-GEN 50-CL(-LINK) part
 ‘part of the 50 apples’

Whatever blocks (22a) is going to block (22b), too, which is a partitive construction that reflects the original head-final order.

The intended reading of (22b) can be rendered by (23a, b), where the NP portion of the whole is not raised.

- (23) a. [ringo 50-ko]-no ichibu
 apple 50-CL-GEN part
 b. [50-ko-no ringo]-no ichibu
 50-CL-LINK apple-GEN part

The question to be addressed, then, is why (21a) cannot be derived from (23a) or (23b) through the movement steps proposed for reverse partitives in Section 3.2. Recall that the relevant part of the bracketed DP in (23) is structured as follows.

¹⁴ This conclusion does not preclude the possibility that (18) underlies the plural reading of (1a), which does not involve a demonstrative. Even in that case, optional movement of CaseP to Spec of DP does not apply, given that this movement is linked to non-specificity (Watanabe 2006), which is incompatible with partitives. See de Hoop (2003) and the references cited there in this connection.

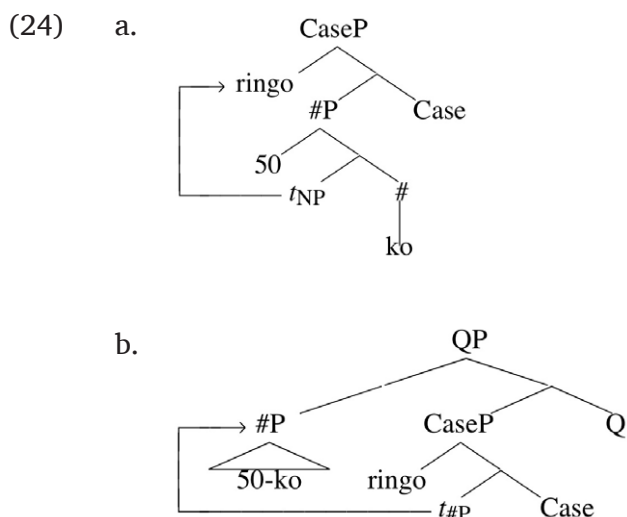

In the case of (24b), it is straightforward to rule out raising of *ringo*, since the #P containing the numeral-classifier sequence intervenes.¹⁵ Incidentally, the trace in (21b) corresponds to this derivational option. But what blocks raising of *ringo* in the case of (24a)?

I would like to suggest that QP is also projected in (24a) above CaseP and that the number features carried by this QP create a locality problem. As argued in Watanabe (2006), the most likely agreement preconditioning movement of #P to Spec of QP as in (24b) is the one that involves number features. Suppose that the same agreement relation holds even when movement of #P to Spec of QP does not take place, as long as #P contains a numeral in its Spec. Raising of an NP contained in that QP becomes impossible, which rules out (21a). Though there may remain further details to be filled in, we can take it to be a virtue of the proposed analysis of reverse partitives that interaction between reverse partitives and numerals can now be addressed in a principled fashion.

To wrap up the discussion, in order to account for the word order effects on semantic interpretation of the whole illustrated in (1)–(3), it is necessary to posit number agreement that targets a bare NP. This agreement is a precondition for the movement that extracts that NP out of the phrase headed by *ichibu*, with subsequent remnant movement reversing the word order. At the same time, the posited number agreement ensures that the whole will be interpreted as plural. The agreement in question exhibits usual locality/minimality effects. The account crucially involves [\pm singular] marking of bare nominals. It follows that a classifier is not needed to express this distinction.

4 Mass nouns

The hypothesis that reverse partitives involve movement enabled by agreement in [–singular] makes non-trivial predictions about whether Japanese has a noun class distinction that is sensitive to [–singular]. The point lies at the heart of the mass/count distinction. It turns out that there are at least two additional classes of nouns that behave differently from the type illustrated in (1)–(3) and discussed so far. I will start with ordinary mass nouns. The idea that they are not special, however, is probably biased by impressions from languages like English. See Lasersohn (2011) for a summary of the research history about the mass/count distinction. The second class of mass nouns to be taken up may lead to modification of the English-centered conception of mass nouns. I

¹⁵ The numeral contained in the lower #P cannot be raised to the higher #P, either, since the whole and a proper part of it cannot be of the same cardinality.

will end this section with remarks from the cross-linguistic perspective to provide a more balanced view on mass nouns.

4.1 Ordinary mass nouns

Substance nouns such as *mud* and *gold* in English cannot be pluralized under normal circumstances. This is one of the characteristic properties of mass nouns. If mass nouns of this type exist in Japanese, it is predicted that they cannot occur in reverse partitives.

The prediction is borne out. Consider the pair of examples in (25).

- (25) a. Osensui-no ichibu-ga moredashita.
contaminated.water-GEN part-NOM leaked.out
'Part of the contaminated water leaked out.'
- b. Ichibu-no osensui-ga moredashita.
part-LINK contaminated.water-NOM leaked.out
'Part of the partitions of contaminated water leaked out.'

Both are possible, but (25b) only has a coerced reading under which the contaminated water is portioned out into multiple discrete units such as storage tanks. No such coerced reading is found in (25a), on the other hand. This observation might be subject to some scepticism in the case of *ichibu*, as a reviewer remarks, since (25a) can be true in the presence of discrete units, as long as the total amount that leaked is small. But if *dai-bubun* 'most', illustrated in (3), is used instead of *ichibu*, we can see clearly that what matters for the truth of the (25a) version is the total volume that leaked out, not the number of discrete units. The contrast is explained if the coerced reading referring to discrete units is linked to the pluralized whole. This means that mass nouns lacking [-singular] cannot be used in reverse partitives. The word order variation exhibited by Japanese partitives thus can be used as a diagnostic test for the mass/count distinction.

Interestingly, one reviewer expresses disagreement with the judgments concerning (25b), saying that it is acceptable without coercion. The existence of such a speaker, however, is not surprising, given another class of nouns that will be examined next.¹⁶

4.2 Plural mass nouns

Word order variation in partitives as a diagnosis for [-singular] marking brings us rather surprising results concerning noun classes of Japanese. To set the stage for discussion, let us review the relevant class in English first.

English has a class of plural mass nouns as illustrated by (26a) and (26b) from Heycock & Zamparelli (2005: 228) and Acquaviva (2008: 88), respectively.

- (26) a. He hasn't got much brains/funds.
b. These funds/resources are insufficient.

As observed in the literature (McCawley 1975; Ojeda 2005; Acquaviva 2008; Lasersohn 2011; and the references cited there), these nouns are always plural, triggering plural agreement, but they cannot be combined with a numeral, as shown in (27) from Ojeda (2005: 392).

- (27) a. The clothes are/*is dirty.
b. *I need a clothes.
c. *I've just bought five clothes.

¹⁶ I have encountered one more speaker of this type.

Morphosyntactically, we are led to conclude that these nouns are always associated with [–singular] marking, which leads, however, to the mass interpretation in this case. See the references cited above for discussion concerning semantic interpretation.

Quite interestingly, Japanese seems to have analogous nouns. Consider the following examples:

- (28) a. *Shikin-no ichibu-ga saiken-shijou-ni nagarekonda.*
 funds-GEN part-NOM bond-market-LOC flowed.into
 b. *Ichibu-no shikin-ga saiken-shijou-ni nagarekonda.*
 part-LINK funds-NOM bond-market-LOC flowed.into
 ‘Some of the funds went into the bond market.’
- (29) a. *Shisan-no ichibu-ga kokugai-ni mochidasareta.*
 assets-GEN part-NOM country.out-LOC was.taken.out
 b. *Ichibu-no shisan-ga kokugai-ni mochidasareta.*
 part-LINK assets-NOM country.out-LOC was.taken.out
 ‘Some of the assets were taken out of the country.’

An important property of the nouns in question is that the (a) and (b) examples are both unambiguous and have an identical interpretation. The situation here thus differs both from the case of count nouns in (1)–(3), where the word order difference creates semantic effects, and from the case of mass nouns, illustrated in (25), where the reverse partitive version is incompatible with the original mass denotation. The unambiguous status of (28a) and (29a) and the semantic identity of (a) and (b) in (28) and (29) point to the fact that nouns like *shikin* ‘funds’ and *shisan* ‘assets’ are always used with [–singular] marking, just like their English counterparts.¹⁷ The [–singular] marking makes possible the inverted order through remnant movement, yielding the mass reading for this class of nouns at the same time, and the absence of singular making is responsible for the lack of ambiguity in (28a) and (29a).

It should be stressed that quantifier selection independently points to the mass status of nouns like *shikin*. (26a) uses *much* instead of *many*. Gillon (1992: note 12) reports the following contrast:

- (30) a. How much brains does Bill have?
 b. *How many brains does Bill have?

Japanese also has a quantifier that is sensitive to the mass/count distinction, as pointed out by Watanabe (2010b: 59), who observes the following contrast:

- (31) a. *John-wa kazu ooku-no hon-o yonda.*
 John-TOP number many-LINK book-ACC read
 ‘John read a large number of books.’
 b. **John-wa kazu ooku-no mizu-o nonda.*
 John-TOP number many-LINK water-ACC drank
 ‘*John drank a large number of water.’

¹⁷ Another logical possibility is that though they have both singular and plural versions, the [±singular] distinction makes no difference. We can put aside this possibility, since the [±singular] distinction is completely superfluous under this scenario.

Crucially, the quantifier *kazu ooku* is incompatible with *shikin*, as shown in (32).

- (32) **Kazu ooku-no shikin-ga saiken-shijou-ni nagarekonda.*
 number many-LINKER funds-NOM bond-market-LOC flowed.into
 ‘*A large number of funds went into the bond market.’

Watanabe (2010b) attributes the ill-formedness of (31b) to the absence of [–singular] marking, but this explanation must be discarded in light of the unacceptability of (32), which involves a plural mass noun. What is common to (31b) and (32) is the combination of a mass noun with *kazu ooku*. This quantifier only allows a count noun as its restrictor, just like *many* in English.¹⁸

Going back to the speaker variation noted in Section 4.1, notice that those speakers who allow (25b) without coercion are treating the noun in question as a mass plural. The reviewer mentioned above claims that the pattern is quite systematic for him/her. If so, plural mass nouns may be more wide spread for such speakers. According to Ojeda (2005), English has many mass plurals. An analogous situation in Japanese is a plausible possibility. The literature even reports that there are languages where mass plurals are predominant, with ordinary mass nouns occupying a less prominent place. According to Mufwene (1980), Lingala, a Bantu language, is one such example, which Ojeda revisits in connection with mass plurals.¹⁹ In this language, names of liquids and substances are productively assigned to the class of mass plurals. A prenominal prefix, characteristic of Bantu, indicates the morpho-syntactic plurality of the Lingala nouns in question, while the use of a numeral is disallowed for them. Examples include items like *ma-fúta* ‘oil’, *ma-sanga* ‘drink’, *má-i* ‘water’, *ma-kilá* ‘blood’, *ma-belé* ‘earth, dirt’, *ma-yéle* ‘wisdom’ and so on, where *ma-* is the plural prefix used for singular/plural pairs like *li-/ma-tói* ‘ear(s)’. Ojeda points out that the situation is similar in Zuni, which uses a suffix for plural marking. Japanese may be more like Lingala and Zuni than English, at least for some speakers. Significantly, Japanese has no overt plural marker for mass plurals. It is quite likely that the absence of overt morphology will create a lot of room for speaker variation.

To summarize, we are led to conclude that Japanese also has mass plurals. Though the extent of this phenomenon is not known at this point, the very existence of mass plurals is completely unexpected from the point of view that regards bare nouns in Japanese as number neutral. It thus falsifies that idea. Their existence is not so surprising, on the other hand, under the view that posits abstract number marking. At the same time, absence of the relevant plural morphology may lead to a lot of variation among speakers in relation to the size of the class. It is an interesting topic for future research to find out how wide spread the phenomenon is and to ask whether there are semantic factors that force eligible nouns to carry the obligatory plural marking even in the absence of visible morphological support. Let me emphasize that the analysis of reverse partitives proposed in Section 3 not only provides evidence that bare nouns in Japanese are not always number neutral, but also contributes to the establishment of a new research agenda regarding the status of mass plurals in Japanese, placing the discussion of the mass/count distinction in Japanese in a broader cross-linguistic context.

¹⁸ On the syntax of *kazu ooku*, see Watanabe (2010b).

Note also that nouns like *shikin* are incompatible with a numeral, as in (i).

(i) **mit-tsu-no shikin*
 three-CL-LINK funds
 ‘*three funds’

¹⁹ See also Contini-Morava’s (2000) discussion of Swahili, which is then taken up by Acquaviva (2008).

5 Comparison with previous studies on partitives

Let us situate the proposed analysis in relation to previous studies on partitives. I focus on how part of the whole should be expressed in Sections 5.1 and 5.2. I will turn to the relation between count syntax and count semantics in Section 5.3.

5.1 Partitives with a numeral

The idea that partitive constructions involve duplication of the NP portion of the whole in the higher region is not new. It has been a fairly influential hypothesis since Jackendoff's (1977) analysis of English. See Ionin, Matushansky & Ruys (2006) and Sleeman & Ihsane (2016) for references. Zamparelli (1998) implements it in terms of movement, according to which (33b) underlies (33a), putting aside further structural details posited in Zamparelli's proposal.

- (33) a. two of the dogs
b. two ~~dogs~~ of the dogs

The overstrike indicates that the higher copy is deleted after movement.

There is a significant difference between cases like (33) and reverse partitives in Japanese, however. For partitives with a numeral, a mismatch in number is perfectly fine, as in (34).

- (34) one ~~dogs~~ of the dogs

Thus, if movement of the lower NP is an essential element of the correct analysis of partitives with a numeral, that movement cannot be driven by the number feature of the higher # head. An alternative that comes to mind is a gender (or noun class) feature carried by a covert version of *part*, which is not represented in (33b) and (34). Zamparelli attributes the part-whole relation to the semantic contribution of *of*, but there is no obstacle to positing a covert version of *part* in his movement analysis.²⁰ Under this modification, the two-NP analysis of partitives with a numeral has the following representation, with the covert version of *part* represented as PART:

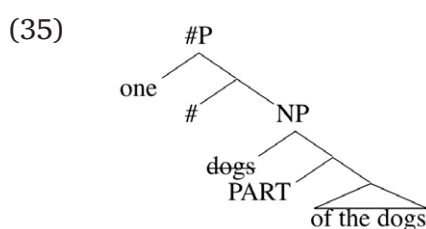

The lower NP lands in Spec of the phrase headed by PART below the #P that hosts a numeral. The singular interpretation is compatible with *dogs* as the higher copy, to the extent that the plural marking of nouns is simply due to agreement with the # head associated with the whole and does not itself feed semantic interpretation for the part.

It is an open question whether partitives with a numeral should be analyzed in terms of the movement of the NP portion of the whole. In Chierchia's (1997) analysis, a covert version of *part* does all the syntactic and semantic work. Movement of the NP portion of

²⁰ Zamparelli's idea is that the semantic job done by *of* is to remove from the set of individuals denoted by the raised NP the supremum that is contributed by the whole. This semantic operation creates the part-whole relation. It is not implausible to imagine that the covert version of *part* posited here might perform the same semantic operation, though the text discussion is neutral on this point.

the whole, however, may help explain which classifier should be used together with a numeral. As illustrated in (36), the classifier appropriate for the whole must be used in Japanese.

- (36) a. Sorera-no ringo-no uchi-no ik-ko-ga kusatteiru.
 those-LINK apple-GEN out.of-LINK one-CL-NOM is.rotten
 ‘One of those apples is rotten.’
 b. Sorera-no hon-no uchi-no is-satsu-ga nusumareta.
 those-LINK book-GEN out.of-LINK one-CL-NOM was.stolen
 ‘One of those books was stolen.’

If it turns out that PART cannot determine the classifier choice, movement of the lower NP must be invoked. Note at the same time that there is no reordering of the head noun with regard to the demonstrative in (36), which suggests either that movement of the lower NP does not take place or that the higher copy is deleted as in Zamparelli’s proposal. The choice is left for future research. It goes well beyond the scope of this paper to give a comprehensive account of various partitive constructions in Japanese, which present a fairly complicated picture as shown in Watanabe (2008). I would just like to point out here that we may need to refer to agreement in gender (or noun class) features to handle classifier selection in partitives if the head noun of the whole is not placed in the proximity of the classifier.

Regardless of whether movement of a constituent containing the head noun of the whole takes place or not, raising of the NP headed by PART to Spec of CaseP gives rise to the correct output for partitives like (36), as in (37).

- (37) [_{CaseP} [NP sorera-no ringo-no uchi-no PART] [_{#P} ik t_{NP} [_# ko]] Case]

At the same time, the #P headed by a classifier cannot be raised to Spec of QP in this type of partitives. What rules out this movement is another question for future research.

5.2 Sauerland and Yatsushiro (2004)

As mentioned in Section 2, Sauerland & Yatsushiro (2004) originally pointed out the interesting number-related semantic properties of partitives involving *hotondo* ‘most’. In their discussion of (38a), they claim that its singular-whole reading in (38b) arises when there is a higher unpronounced noun *pages*, with the structure corresponding to (38b) lying behind (38a) under that reading.

- (38) a. John-wa hon-no hotondo-o yomi-oeta.
 John-TOP book-GEN most-ACC read-finished
 ‘John has finished reading most of the book(s).’
 b. John has finished reading most pages of the book.

Though it may embody an important insight concerning the interpretation of partitives, a solution of this kind is inadequate in two respects. On the one hand, a different covert noun must be posited for various expressions of the singular whole. And it is not obvious what noun should be used for cases like (2). It must be noted further that addition of an overt noun meaning ‘page’ to (38a) leads to degradation, as in (39).

- (39) *John-wa hon-no hotondo-no peeji-o yomi-oeta.
 John-TOP book-GEN most-LINK page-ACC read-finished

On the other hand, the singular-whole reading is not limited to *hotondo* but is also found with a clearly nominal head such as *ichibu* and *(dai-)bubun*. It is not clear how to reconcile them with a covert noun like *pages*. We might say that items like *pages* belong to a class of part nouns²¹ and that Sauerland & Yatsushiro's analysis tries to capture the part-whole relation of partitive constructions in the case of a singular whole. The part-whole relation exists in the case of a plural whole as well, however. Chierchia (1997) and Moltmann (1998) take the position that a general notion of part can cover both of these cases. The analysis proposed in this paper builds on the idea that there is a lexical item that encodes this general notion of part. There is no need to posit a specialized covert noun like *pages*. PART will do. In discussing English partitives like *most of the book*, Sauerland & Yatsushiro indeed posit covert *parts*, as in *most parts of the book* (See their (8a)). The point of the observation concerning (1) and (3) is that the interpretation of the whole varies depending on the word order, while an overt part noun is kept constant in the two word order options. It is therefore not appropriate to posit a part noun only in the case of a singular whole. A part noun is an essential ingredient of partitive constructions in general.

5.3 Count nouns vs. nouns of the furniture-type

We have seen that bare nominals can be associated with number specification in Japanese. This assumption plays a crucial role in producing the word order effects on number interpretation of partitives. Using partitives as a litmus test for plurality, we are even led to conclude that plural mass nouns exist in Japanese. All these entail that we need to recognize the familiar mass/count distinction in Japanese.

A recent study by Sudo (to appear) also takes note of the interpretive properties of examples like (2), arguing that there are nouns with “countable” denotations in Japanese, but his discussion of partitives falls short of establishing the mass/count distinction. He indeed distinguishes “countable nouns” in Japanese from “count nouns” in languages like English. In order to see what is at stake, let us review Sudo's argument and relate it to the discussion of the mass/count distinction in the literature.

Sudo's point about partitives is that examples like (40a) have truth conditions based exclusively on the number of individuated objects (books in this case), while cases like (40b) are ambiguous, allowing an amount-based interpretation (ex. volume) as well as a reading that counts unexpressed multiple containers such as glasses.²²

- (40) a. Taro-wa hotondo-no hon-o yonda.
 Taro-TOP most-LINK book-ACC read
 ‘Taro read most of the books.’
- b. Taro-wa hotondo-no mizu-o nonda.
 Taro-TOP most-LINK water-ACC drank
 ‘Taro drank most of the water.’

²¹ This possibility is not plausible for the Japanese noun *peeji*, though. It functions as a measure noun, as can be seen from the fact that it is directly combined with a numeral, as in *go-peeji* ‘five pages’. Its measure noun status is probably responsible for the ill-formedness of (39) as well. See Watanabe (2010b, 2012, 2014) for the analysis of measure nouns in Japanese, where their number defective nature is discussed. I will briefly come back to measure nouns in the final section.

In an updated analysis by Sauerland & Yatsushiro (2017), the silent noun *mass* is posited. The problem raised by the constructions that feature *ichibu* and *(dai-)bubun*, however, does not go away.

²² Note that this means that *mizu* ‘water’ is a mass plural in Sudo's grammar. Acquiva (2008: 19) points out that there are several languages where the noun for ‘water’ is plural. Mufwene (1980: 1029) observes that coercion of mass plurals is possible for names of food such as salted fish.

He then concludes that Japanese distinguishes between “countable nouns” such as *hon* and “uncountable nouns” such as *mizu*. The distinction drawn is entirely semantic. He does not touch on questions about the syntax of partitives.

The observation limited to semantic properties, however, fails to rule out the possibility that “countable nouns” in Sudo’s sense correspond to *furniture*-type nouns in English. McCawley (1975) observes that there must be several pieces of furniture for (41) to be true.

(41) Fred has a lot of furniture.

Bale and Barner (2009) point out that (42a) expresses numerical comparison, whereas volume matters for (42b).²³

- (42) a. Esme has more furniture than Seymour.
 b. Esme has more butter/water/toothpaste than Seymour.

These observations do not change the fact that *furniture* is a mass noun, as demonstrated by the impossibility of **three furnitures* and **many furnitures*. The same point will apply to Sudo’s observation on partitives, if it is not accompanied by the kind of syntactic analysis presented in this article.²⁴ As is amply shown above, we can learn a lot more about number marking of bare nouns and the mass/count distinction in Japanese from an in-depth study of partitive constructions. Sudo discusses only reverse partitives with *hotondo* and does not take up partitives with the head-final order in any detail.

It should be mentioned in this connection that there are recent studies (Chierchia 2010; Bale & Barner 2012; Zhang 2012) that claim that an appropriate way of characterizing nouns with count semantics in classifier languages is to regard them as analogous to *furniture*-type nouns in English. Though Chierchia and Zhang limit their discussion to Chinese, Bale & Barner take up Inagaki & Barner’s (2009) experiments, cited also by Sudo, which employ comparative constructions in Japanese. The results indicate that nouns like *sara* ‘plate’ produce judgments based on number, while nouns like *hamigakiko* ‘toothpaste’ do not, apparently replicating the interpretive contrast between (42a) and (42b). These authors deny the presence of count nouns in classifier languages, on the grounds that relevant nouns do not exhibit count syntax. Hence the conclusion that nouns with count semantics in classifier languages are equivalent to *furniture*-type nouns.

Count semantics itself is thus neutral with respect to the mass/count distinction. Number-marked bare nouns, on the other hand, point to the presence of count syntax. Given the analysis of partitives proposed above, the hypothesis that nouns with count semantics in Japanese are *furniture*-type nouns is no longer tenable. Cheng (2012) argues that *furniture*-type nouns must be set aside as a special class in Chinese. If so, the rest of nouns with count semantics cannot be *furniture*-type nouns. Furthermore, de Belder (2013) and Alexiadou (2015) come to the conclusion that in languages like Dutch, English, and Greek, syntactico-semantic properties of *furniture*-type nouns are due to a special kind of affix, which is sometimes null. It is very hard to motivate such a special null affix for the entire class of relevant nouns in Japanese.

²³ For the record, it should also be noted that McCawley’s judgments concerning *furniture* in comparatives are different. See Bale & Barner (2009: Note 6) for comments.

²⁴ For fairness’s sake, it should be mentioned that Sudo presents two other types of evidence for countable denotations in Japanese. One of them has to do with *tasuu* ‘a large number’ and similar items. *Tasuu* is the Sino-Japanese version of *kazu ooku* ‘a large number’, illustrated in (31). This quantifier test provides solid evidence that the genuine mass/count distinction exists in Japanese, though it may be orthogonal to number marking of bare nouns, as demonstrated in Section 4.2.

6 Conclusion

To conclude, the [\pm singular] distinction carried by Japanese bare nominals is masked by the absence of overt plural marking and the lack of number agreement morphology. For that reason, bare nominals are ambiguous with regard to number interpretation in most syntactic contexts including cases like (1a), giving an impression of number neutrality. Reverse partitives, however, only allow the plural reading for the whole, exposing the number distinction that is usually hidden. This interpretive characteristic of reverse partitives is accounted for by an analysis that crucially refers to agreement in terms of [$-\text{singular}$]. The partitive test can also be used to identify plural mass nouns in Japanese. The proposed account makes sure that the word order effects on number interpretation of partitives should be as they are. The challenge for proponents of number-neutrality of bare nominals in classifier languages is to provide an alternative principled account of the systematic word order effects on number interpretation of partitives that explains why it is reverse partitives that disallow the singular-whole interpretation.

The above conclusion entails that the mass/count distinction is represented in syntax for bare nominals in Japanese. The behavior of the quantifier *kazu ooku*, reviewed in Section 4.2, provides additional evidence that Japanese distinguishes between count nouns and mass nouns. Thus, it is wrong to focus on the use of numeral classifiers to decide whether bare nominals exhibit the mass/count distinction. The obligatory use of a classifier in the presence of a numeral requires a separate account. See Watanabe (2010b) for a feature-based approach to the behavior of numerals and classifiers in Japanese. Yi (2009), Nomoto (2013), and Bale & Coon (2014) also question the validity of using classifiers to diagnose nominal denotations as mass.

In fact, it is not correct to say that every noun with count semantics in classifier languages needs to be mediated by a classifier when used together with a numeral. Measure nouns in Japanese such as *meeteru* ‘meter’ and *nen* ‘year’ are directly combined with a numeral.²⁵ See Watanabe (2010b, 2012, 2014) in this connection. Furthermore, Nomoto (2013: 15–17) points out that direct combination of a numeral with a noun is actually more wide spread in Japanese, found outside the domain of measure nouns as well.

These conclusions are already anticipated by Watanabe’s (2006: 278–279) observation that distributive universal quantification distinguishes between count and mass nouns in Japanese, as illustrated in (43).

- (43) a. John-wa dono hon-mo yonda.
 John-TOP which book-MO read
 ‘John read every book.’
 b. *John-wa dono mizu-mo nonda.
 John-TOP which water-MO drank
 ‘John drank all the water.’

Japanese does not make use of a classifier for distributive universal quantification, which requires singular nouns not only in English (*each* and *every*) but more generally, as Gil’s (1995) cross-linguistic study demonstrates. Thus, the contrast in (43) indicates that singularity is possible in Japanese without the help of a classifier. The idea, mentioned in Section 5.3 above, that nouns with count semantics in classifier languages correspond to *furniture*-type nouns in English is falsified again, for *furniture*-type nouns resist distributive universal quantification, as in **every furniture*, a fact noted by Rothstein (2010). Probably,

²⁵ In his discussion of Chinese, Gebhardt (2011) notes that so-called mensural classifiers are nouns, which means that those nouns do not need a classifier when combined with a numeral.

it is about time to change our mind and consider that the universality of the mass/count distinction is the null hypothesis. Deal (2017) also reaches the same conclusion on the basis of an illuminating analysis of Nez Perce, where the mass/count distinction shows up unambiguously only in relation to the number morphology of the attributive adjective in the structure that features a quantifier.

Abbreviations

ACC = accusative, CL = classifier, GEN = genitive, LINK = linker, LOC = locative, NEG = negation, NOM = nominative, TOP = topic

Additional File

The additional file for this article can be found as follows:

- **Appendix.** The count status of *sequences, ropes, and lines*. DOI: <https://doi.org/10.5334/gjgl.116.s1>

Acknowledgements

The core part of the proposed analysis was presented at the theoretical and comparative syntax session of the 19th International Congress of Linguists, held at the University of Geneva in July 2013. For helpful feedback, I would like to thank the audience there, including Byron Ahn, Anna Cardinaletti, Giuliana Giusti, Hideki Kishimoto, Dylan Tsai, and Saeko Urushibara. An earlier version, which also discusses implications of the proposed analysis for the agreement pattern displayed by partitive subjects in Modern Hebrew, appeared as an online publication at the website of the conference (http://www.cil19.org/uploads/documents/Count_Syntax_and_the_Partitivity.pdf). I am also grateful to participants in a lecture series at Kwansai-Gakuin University in September 2013, where major ideas of this paper were presented, as well as to anonymous reviewers. The research reported here is supported by Grant-in-Aid for Scientific Research (C) 22520492 and (C) 15K02591 from the Japan Society for the Promotion of Science.

Competing Interests

The author has no competing interests to declare.

References

- Acquaviva, Paolo. 2008. *Lexical plurals*. Oxford: Oxford University Press.
- Alexiadou, Artemis. 2015. Deriving fake mass nouns. In Thuy Buli & Deniz Özyıldız (eds.), *Proceedings of NELS* 45(1). 11–24. Amherst, MA: University of Massachusetts, GLSA Publications.
- Bale, Alan C. & David Barner. 2009. The interpretation of functional heads: Using comparatives to explore the mass/count distinction. *Journal of Semantics* 26. 217–252. DOI: <https://doi.org/10.1093/jos/ffp003>
- Bale, Alan C. & David Barner. 2012. Semantic triggers, linguistic variation and the mass-count distinction. In Diane Massam (ed.), *Count and mass across languages*, 238–260. Oxford: Oxford University Press. DOI: <https://doi.org/10.1093/acprof:oso/9780199654277.003.0013>
- Bale, Alan C. & Jessica Coon. 2014. Classifiers are for numerals, not for nouns. *Linguistic Inquiry* 45. 695–707. DOI: https://doi.org/10.1162/LING_a_00170
- Borer, Hagit. 2005. *In name only*. Oxford: Oxford University Press.
- Cheng, Lisa Lai-Sheng. 2012. Counting and classifiers. In Diane Massam (ed.), *Count and mass across languages*, 199–219. Oxford: Oxford University Press. DOI: <https://doi.org/10.1093/acprof:oso/9780199654277.003.0011>

- Chierchia, Gennaro. 1997. Partitives, reference to kinds and semantic variation. In Aaron Lawson (ed.), *Proceedings of SALT VII*. 73–98. Ithaca, NY: Cornell University, CLC Publications. DOI: <https://doi.org/10.3765/salt.v7i0.2792>
- Chierchia, Gennaro. 1998. Reference to kinds across languages. *Natural Language Semantics* 6. 339–405. DOI: <https://doi.org/10.1023/A:1008324218506>
- Chierchia, Gennaro. 2010. Mass nouns, vagueness and semantic variation. *Synthèse* 174. 99–149. DOI: <https://doi.org/10.1007/s11229-009-9686-6>
- Chomsky, Noam. 2000. Minimalist inquiries. In Roger Martin, David Michaels & Juan Uriagereka (eds.), *Step by step: Essays on minimalist syntax in honor of Howard Lasnik*, 89–155. Cambridge, MA: MIT Press.
- Contini-Morava, Ellen. 2000. Noun class as number in Swahili. In Ellen Contini-Morava & Yishai Tobin (eds.), *Between grammar and lexicon*, 3–30. Amsterdam: John Benjamins. DOI: <https://doi.org/10.1075/cilt.183.05con>
- Deal, Amy Rose. 2017. Countability distinctions and semantic variation. *Natural Language Semantics* 25. 125–171. DOI: <https://doi.org/10.1007/s11050-017-9132-0>
- de Belder, Marijke. 2013. Collective mass affixes: When derivation restricts functional structure. *Lingua* 126. 32–50. DOI: <https://doi.org/10.1016/j.lingua.2012.11.008>
- Doetjes, Jenny. 2012. Count/mass distinctions across languages. In Klaus von Heusinger, Claudia Maienborn & Paul Portner (eds.), *Semantics* 3. 2559–2580. Berlin: De Gruyter Mouton. DOI: <https://doi.org/10.1515/9783110253382.2559>
- Gebhardt, Lewis. 2011. Classifiers are functional. *Linguistic Inquiry* 42. 125–130. DOI: https://doi.org/10.1162/LING_a_00030
- Gil, David. 1995. Universal quantifiers and distributivity. In Emmon Bach, Eloise Jelinek, Angelika Kratzer & Barbara H. Partee (eds.), *Quantification in natural languages*, 321–362. Dordrecht: Kluwer.
- Gillon, Brendan S. 1992. Towards a common semantics for English count and mass nouns. *Linguistics and Philosophy* 15. 597–639. DOI: <https://doi.org/10.1007/BF00628112>
- Hallman, Peter. 2016. Universal quantification as degree modification in Arabic. *Glossa: a journal of general linguistics* 1(1). 26. 1–31. DOI: <https://doi.org/10.5334/gjgl.131>
- Harbour, Daniel. 2007. *Morphosemantic number*. Dordrecht: Springer.
- Heycock, Caroline & Roberto Zamparelli. 2005. Friends and colleagues: Plurality, coordination, and the structure of DP. *Natural Language Semantics* 13. 201–270. DOI: <https://doi.org/10.1007/s11050-004-2442-z>
- Hoeksema, Jacob. 1996. Introduction. In Jacob Hoeksema (ed.), *Partitives*, 1–24. Berlin: Mouton de Gruyter.
- Hoop, Helen de. 2003. Partitivity. In Lisa Cheng & Rint Sybesma (eds.), *The second Glot-International state-of-the-article book*, 179–212. Berlin: Mouton de Gruyter.
- Inagaki, Shunji & David Barner. 2009. Countability in absence of count syntax: Evidence from Japanese quantity judgements. In Shunji Inagaki, Makiko Hirakawa, Setsuko Arita, Yahiro Hirakawa, Hiromi Morikawa, Mineharu Nakayama, Hidetosi Sirai & Jessica Tsubakita (eds.), *Studies in Language Sciences* 8. 111–125. Tokyo: Kurosio.
- Ionin, Tania & Ora Matushansky. 2006. The composition of complex cardinals. *Journal of Semantics* 23. 315–360. DOI: <https://doi.org/10.1093/jos/ffl006>
- Ionin, Tania, Ora Matushansky & E. G. Ruys. 2006. Parts of speech: Toward a unified semantics for partitives. In Christopher Davis, Amy Rose Deal & Yuri Zabbal (eds.), *Proceedings of NELS* 36. 357–370. Amherst, MA: University of Massachusetts, GLSA Publications.
- Jackendoff, Ray. 1977. *X-bar syntax*. Cambridge, MA: MIT Press.
- Kayne, Richard S. 2016. The unicity of *there* and the definiteness effect. Unpublished ms. New York: New York University.

- Kennedy, Christopher. 2013. A scalar semantics for scalar readings of number words. In Ivano Caponigro & Carlo Cecchetto (eds.), *From grammar to meaning: The spontaneous logicity of language*, 172–200. Cambridge: Cambridge University Press. DOI: <https://doi.org/10.1017/CBO9781139519328.010>
- Krifka, Manfred. 1989. Nominal reference, temporal constitution and quantification in event semantics. In Renate Bartsch, Johan van Benthem & Peter van Emde Boas (eds.), *Semantics and contextual expressions*, 75–115. Dordrecht: Foris.
- Krifka, Manfred. 1995. Common nouns: A contrastive analysis of Chinese and English. In Gregory N. Carlson & Francis Jeffrey Pelletier (eds.), *The generic book*, 398–411. Chicago, IL: University of Chicago Press.
- Lasersohn, Peter. 2011. Mass nouns and plurals. In Klaus von Heusinger, Claudia Maienborn & Paul Portner (eds.), *Semantics 2*. 1131–1153. Berlin: De Gruyter Mouton. DOI: <https://doi.org/10.1515/9783110255072.1131>
- Link, Godehard. 1983. The logical analysis of plurals and mass terms: A lattice-theoretical approach. In Rainer Bäuerle, Christoph Schwarze & Arnim von Stechow (eds.), *Meaning, use, and interpretation of language*, 302–323. Berlin: Walter de Gruyter. DOI: <https://doi.org/10.1515/9783110852820.302>
- Martin, Samuel E. 1975. *A reference grammar of Japanese*. New Haven, CT: Yale University Press.
- McCawley, James. 1975. Lexicography and the count-mass distinction. In Cathy Cogen, Henry Thompson, Graham Thurgood, Kenneth Whistler & James Wright (eds.), *Proceedings of the first annual meeting of the Berkeley Linguistics Society*, 314–321. Berkeley, CA: University of California, Berkeley Linguistics Society.
- Moltmann, Friederike. 1998. Part structures, integrity, and the mass-count distinction. *Synthese* 116. 75–111. DOI: <https://doi.org/10.1023/A:1005046308299>
- Mufwene, Salikoko S. 1980. Number, countability and markedness in Lingala LI-/MA-noun class. *Linguistics* 18. 1019–1052. DOI: <https://doi.org/10.1515/ling.1980.18.11-12.1019>
- Nakanishi, Kimiko & Satoshi Tomioka. 2004. Japanese plurals are exceptions. *Journal of East Asian Linguistics* 13. 113–140. DOI: <https://doi.org/10.1023/B:JEAL.0000019058.46668.c1>
- Nevins, Andrew. 2011. Marked targets versus marked triggers and impoverishment of the dual. *Linguistic Inquiry* 42. 413–444. DOI: https://doi.org/10.1162/LING_a_00052
- Nomoto, Hiroki. 2013. *Number in classifier languages*. Minneapolis, MN: University of Minnesota dissertation.
- Noyer, Rolf. 1997. *Features, positions, and affixes in autonomous morphological structure*. New York, NY: Garland.
- Ojeda, Almerindo E. 2005. The paradox of mass plurals. In Salikoko S. Mufwene, Elaine J. Francis & Rebecca S. Wheeler (eds.), *Polymorphous linguistics: Jim McCawley's legacy*, 389–410. Cambridge, MA: MIT Press.
- Paul, Ileana. 2012. General number and the structure of DP. In Diane Massam (ed.), *Count and mass across languages*, 99–111. Oxford: Oxford University Press. DOI: <https://doi.org/10.1093/acprof:oso/9780199654277.003.0006>
- Pelletier, Francis Jeffrey. 2012. Lexical nouns are both + MASS and + COUNT, but they are neither + MASS not + COUNT. In Diane Massam (ed.), *Count and mass across languages*, 9–26. Oxford: Oxford University Press.
- Quine, Willard van Orman. 1960. *Word and object*. Cambridge, MA: MIT Press.
- Rizzi, Luigi. 1990. *Relativized Minimality*. Cambridge, MA: MIT Press.

- Rothstein, Susan. 2010. Counting and the mass/count distinction. *Journal of Semantics* 27. 343–398. DOI: <https://doi.org/10.1093/jos/ffq007>
- Sauerland, Uli, Jan Anderssen & Kazuko Yatsushiro. 2005. The plural is semantically unmarked. In Stephan Kesper & Marga Reis (eds.), *Linguistic evidence*, 413–434. Berlin: Mouton de Gruyter. DOI: <https://doi.org/10.1515/9783110197549.413>
- Sauerland, Uli & Kazuko Yatsushiro. 2004. A silent noun in partitives. In Keir Moulton & Matthew Wolf (eds.), *Proceedings of NELS* 34. 505–516. Amherst, MA: University of Massachusetts, GLSA Publications.
- Sauerland, Uli & Kazuko Yatsushiro. 2017. Two nouns in partitives: Evidence from Japanese. *Glossa: a journal of general linguistics* 2(1). 13. 1–29. DOI: <https://doi.org/10.5334/gjgl.171>
- Sleeman, Petra & Tabea Ihsane. 2016. Gender mismatches in partitive constructions with superlatives in French. *Glossa: a journal of general linguistics* 1(1). 35. 1–25. DOI: <https://doi.org/10.5334/gjgl.137>
- Sudo, Yasutada. To appear. Countable nouns in Japanese. In *Proceedings of WAFL* 11. Cambridge, MA: MIT Working Papers in Linguistics.
- Watanabe, Akira. 2006. Functional projections of nominals in Japanese: Syntax of classifiers. *Natural Language and Linguistic Theory* 24. 241–306. DOI: <https://doi.org/10.1007/s11049-005-3042-4>
- Watanabe, Akira. 2008. The structure of DP. In Shigeru Miyagawa & Mamoru Saito (eds.), *The Oxford handbook of Japanese linguistics*, 513–540. Oxford: Oxford University Press. DOI: <https://doi.org/10.1093/oxfordhb/9780195307344.013.0018>
- Watanabe, Akira. 2009. Measure phrases in PP. In Yukio Otsu (ed.), *Proceedings of the Tenth Tokyo Conference on Psycholinguistics*, 1–25. Tokyo: Hituzi Syobo.
- Watanabe, Akira. 2010a. Notes on nominal ellipsis and the nature of *no* and classifiers in Japanese. *Journal of East Asian Linguistics* 19. 61–74. DOI: <https://doi.org/10.1007/s10831-009-9052-1>
- Watanabe, Akira. 2010b. Vague quantity, numerals, and natural numbers. *Syntax* 13. 37–77. DOI: <https://doi.org/10.1111/j.1467-9612.2009.00131.x>
- Watanabe, Akira. 2012. Measure words as nouns: A perspective from silent years. *Studia Linguistica* 66. 181–205. DOI: <https://doi.org/10.1111/j.1467-9582.2012.01190.x>
- Watanabe, Akira. 2014. 1-deletion: Measure nouns vs. classifiers. In Mikio Giriko, Kyoko Kanzaki, Naonori Nagaya, Akiko Takemura & Timothy J. Vance (eds.), *Japanese/Korean Linguistics* 22. 245–260. Stanford, CA: CSLI Publications.
- Watanabe, Akira. 2017. Natural language and set-theoretic conception of natural number. *ActaLinguisticaAcademica* 64. 125–151. DOI: <https://doi.org/10.1556/2062.2017.64.1.4>
- Wilhelm, Andrea. 2008. Bare nouns and number in Dëne Sųłiné. *Natural Language Semantics* 16. 39–68. DOI: <https://doi.org/10.1007/s11050-007-9024-9>
- Yi, Byeong-Uk. 2009. Chinese classifiers and count nouns. *Journal of Cognitive Science* 10. 209–225.
- Zamparelli, Roberto. 1998. A theory of kinds, partitives and of/z possessives. In Artemis Alexiadou & Chris Wilder (eds.), *Possessors, predicates and movement in the determiner phrase*, 259–301. Amsterdam: John Benjamins.
- Zhang, Niina Ning. 2012. Countability and numeral classifiers in Mandarin Chinese. In Diane Massam (ed.), *Count and mass across languages*, 220–237. Oxford: Oxford University Press. DOI: <https://doi.org/10.1093/acprof:oso/9780199654277.003.0012>
- Zweig, Eytan. 2009. Number-neutral bare plurals and the multiplicity implicature. *Linguistics and Philosophy* 32. 353–407. DOI: <https://doi.org/10.1007/s10988-009-9064-3>

How to cite this article: Watanabe, Akira. 2017. The mass/count distinction in Japanese from the perspective of partitivity. *Glossa: a journal of general linguistics* 2(1): 98.1–26, DOI: <https://doi.org/10.5334/gjgl.116>

Submitted: 04 April 2016 **Accepted:** 28 June 2017 **Published:** 10 November 2017

Copyright: © 2017 The Author(s). This is an open-access article distributed under the terms of the Creative Commons Attribution 4.0 International License (CC-BY 4.0), which permits unrestricted use, distribution, and reproduction in any medium, provided the original author and source are credited. See <http://creativecommons.org/licenses/by/4.0/>.



Glossa: a journal of general linguistics is a peer-reviewed open access journal published by Ubiquity Press.

OPEN ACCESS 